

High Voltage Fast-Switching NPN Power Transistor

Features

- Very High Switching Speed (Typical 120ns@1.0A)
- Minimum Lot-to-Lot hFE Variation
- Low VCE(sat) (Typical 200mV@1.0A/0.25A)
- Wide Reverse Bias S.O.A

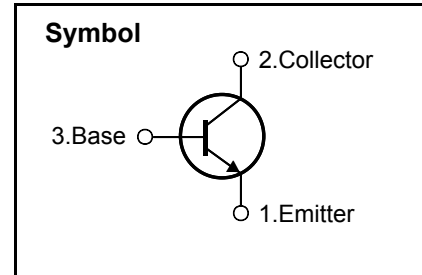

General Description

This devices is designed for high voltage, high speed switching characteristic required such as lighting system, switching regulator, inverter and deflection circuit.

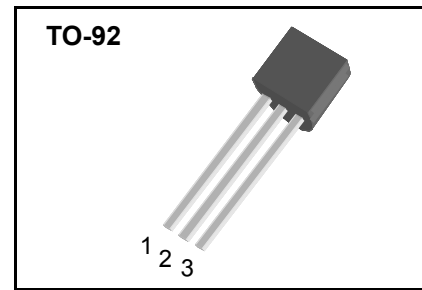

Absolute Maximum Ratings

Symbol	Parameter	Value	Units
V_{CES}	Collector-Emitter Voltage ($V_{BE} = 0$)	700	V
V_{CEO}	Collector-Emitter Voltage ($I_B = 0$)	400	V
V_{EBO}	Emitter-Base Voltage ($I_C = 0$)	9.0	V
I_C	Collector Current	1.5	A
I_{CM}	Collector Peak Current ($t_p < 5$ ms)	3.0	A
I_B	Base Current	0.75	A
I_{BM}	Base Peak Current ($t_p < 5$ ms)	1.5	A
P_C	Total Dissipation at $T_A = 25$ °C	1.1	W
T_{STG}	Storage Temperature	- 65 ~ 150	°C
T_J	Max. Operating Junction Temperature	150	°C

Thermal Characteristics

Symbol	Parameter	Value	Units
$R_{\theta JA}$	Thermal Resistance, Junction-to-Ambient	113.6	°C/W

SBN13003

Electrical Characteristics ($T_C = 25\text{ }^\circ\text{C}$ unless otherwise noted)

Symbol	Parameter	Condition	Min	Typ	Max	Units
I_{CEV}	Collector Cut-off Current ($V_{BE} = -1.5V$)	$V_{CE} = 700V$ $V_{CE} = 700V$ $T_C = 100\text{ }^\circ\text{C}$	-	-	1.0 5.0	mA
$V_{CEO(sus)}$	Collector-Emitter Sustaining Voltage ($I_B = 0$)	$I_C = 10\text{ mA}$	400	-	-	V
$V_{CE(sat)}$	Collector-Emitter Saturation Voltage	$I_C = 0.5A$ $I_B = 0.1A$ $I_C = 1.0A$ $I_B = 0.25A$ $I_C = 1.5A$ $I_B = 0.5A$	-	-	0.3 0.5 1.0	V
$V_{BE(sat)}$	Base-Emitter Saturation Voltage	$I_C = 0.5A$ $I_B = 0.1A$ $I_C = 1.0A$ $I_B = 0.25A$	-	-	1.0 1.2	V
h_{FE}	DC Current Gain	$I_C = 0.5A$ $V_{CE} = 2V$ $I_C = 1.0A$ $V_{CE} = 2V$	10 5	-	30 25	
t_{on} t_s t_f	Resistive Load Turn-On Time Storage Time Fall Time	$I_C = 1.0A$ $V_{CC} = 125V$ $I_{B1} = 0.2A$ $I_{B2} = -0.2A$ $T_P = 25\mu s$	-	0.2 1.5 0.15	1.0 3.0 0.4	μs
t_s t_f	Inductive Load Storage Time Fall Time	$V_{CC} = 15V$ $I_C = 1.0A$ $I_{B1} = 0.2A$ $I_{B2} = -0.5A$ $L = 0.35mH$ $V_{clamp} = 300V$	-	2.0 0.12	4.0 0.3	μs
t_s t_f	Inductive Load Storage Time Fall Time	$V_{CC} = 15V$ $I_C = 1.0A$ $I_{B1} = 0.2A$ $I_{B2} = -0.5A$ $L = 0.35mH$ $V_{clamp} = 300V$ $T_C = 100\text{ }^\circ\text{C}$	-	2.4 0.15	5.0 0.4	μs

※ Notes :

Pulse Test : Pulse width $\leq 300\mu s$, Duty cycle $\leq 2\%$



Fig 1. Static Characteristics

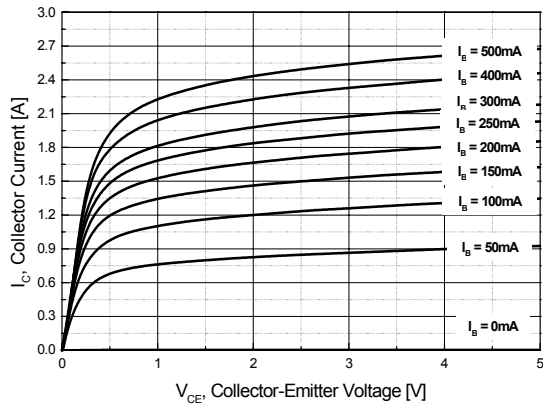

Fig 2. DC Current Gain

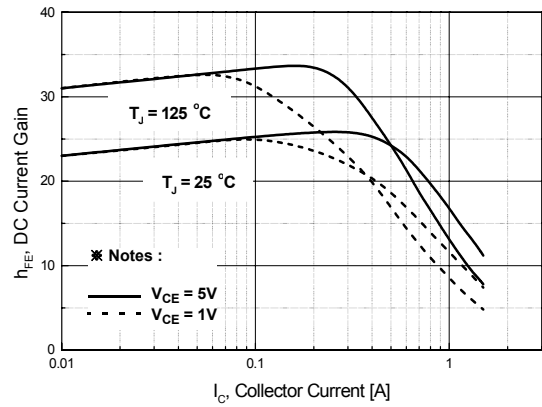

Fig 3. Collector-Emitter Saturation Voltage

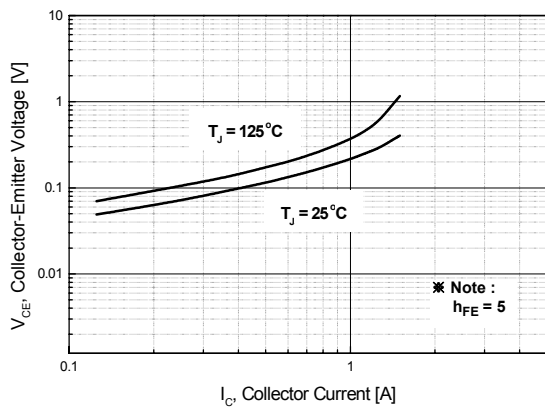

Fig 4. Base-Emitter Saturation Voltage

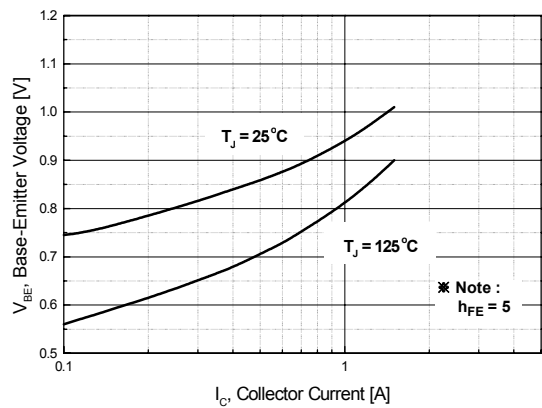

Fig 5. Resistive Load Fall Time

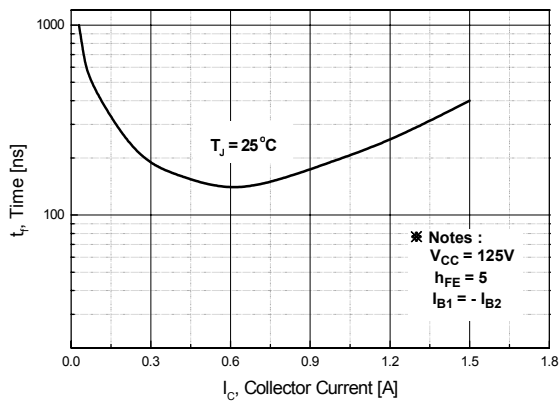
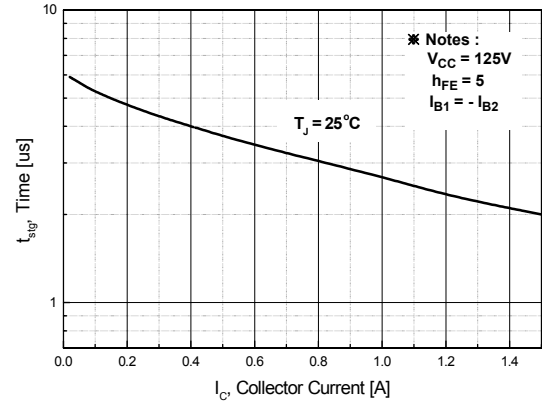

Fig 6. Resistive Load Storage Time



SBN13003

Fig 7. Safe Operation Areas

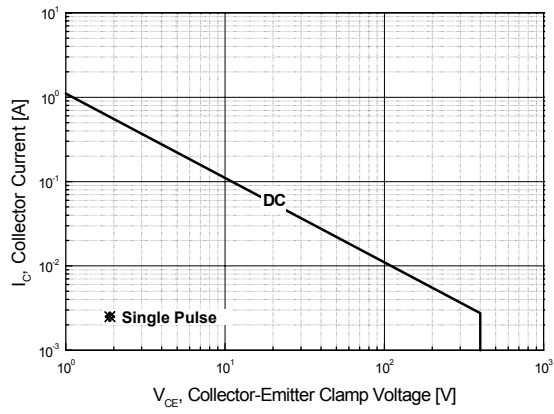
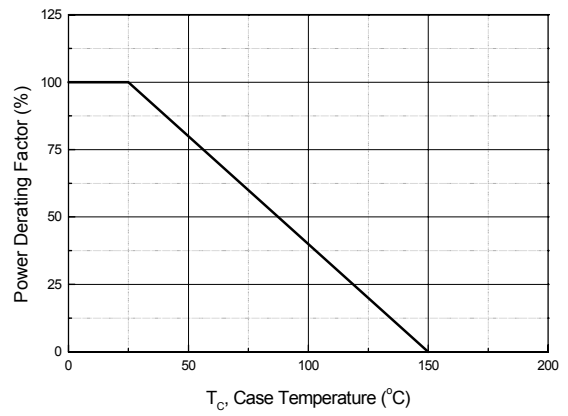
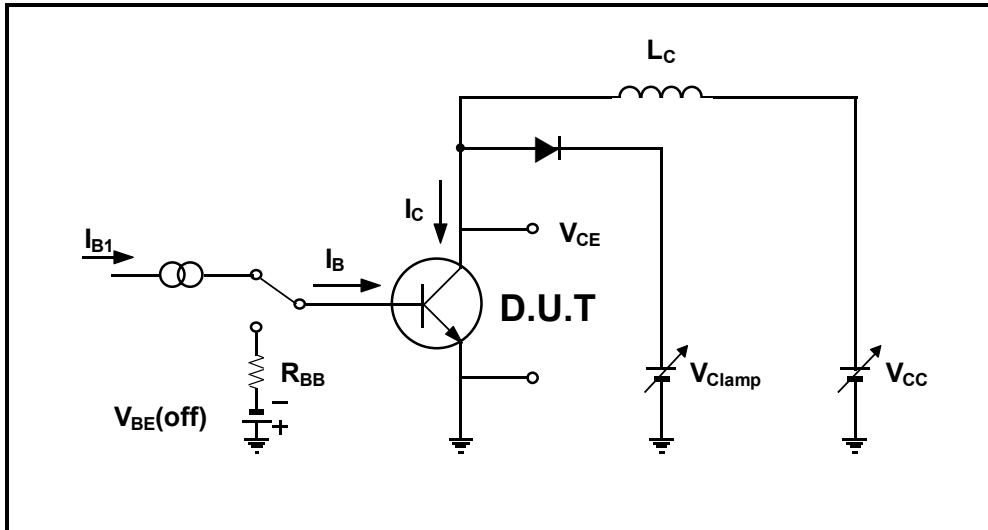

Fig 8. Power Derating Curve



Inductive Load Switching & RBSOA Test Circuit



Resistive Load Switching Test Circuit

